

Data Sheet:
SSRI-32A-DC

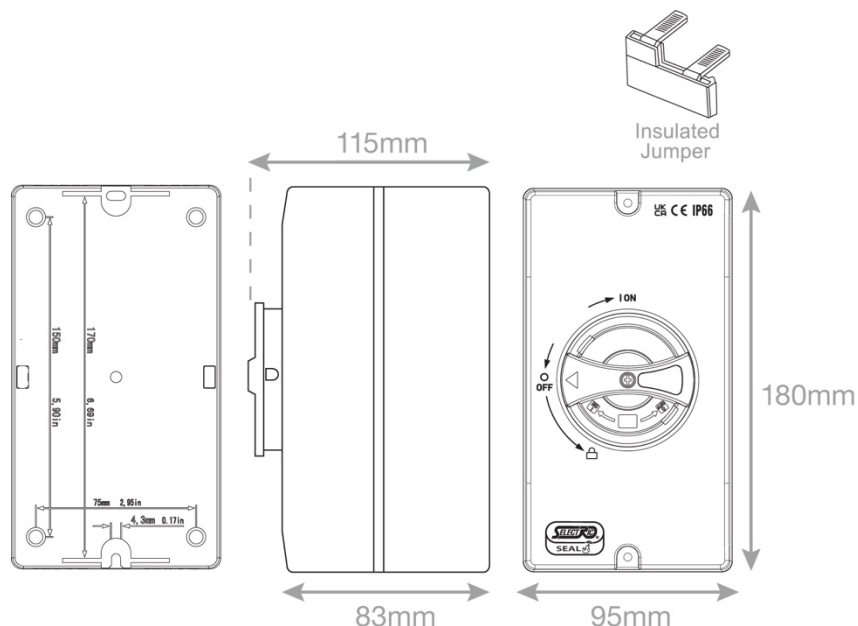

Code:	SSRI-32A-DC
Description:	IP66 32A 600-1500V DC Isolator Switch, 4 Pole
Range:	Selectric Seal IP65 - IP68 Rated Accessories
Colour:	Grey & black
Ingress Protection:	IP66
Material:	Polycarbonate
Included:	2 x insulated jumpers & instructions
Weight:	0.62kg
Inner Carton Quantity:	1
Inner Carton Weight:	0.62kg
Guarantee:	1 year
Barcode:	5025117028735
Commodity Code:	8536 508090
Standards:	BS EN 60947-3
Packaging:	Box
Notes:	<ul style="list-style-type: none"> • Impact resistant base and cover • Lockable in OFF position (up to 3 padlocks) • 20mm knockouts • Insulated jumpers allow user to set desired isolator wiring arrangement • Surface mounting with polycarbonate housing



Selectric reserves the right to withdraw, improve, or modify any design without prior notification.
 Selectric cannot be held responsible for the incorrect application / installation of any product.