

Data Sheet : SSRI-16A

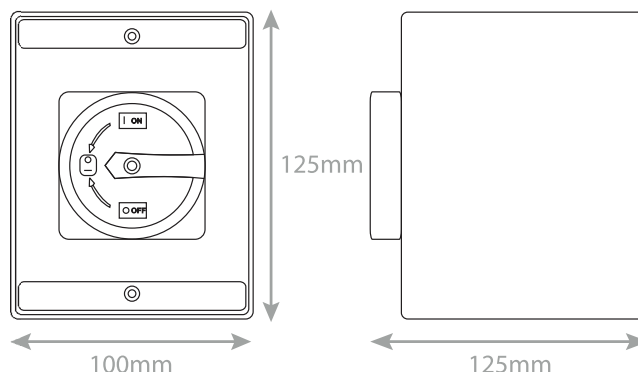

Code	SSRI-16A
Description	IP65 Rated 16 Amp / 8kW Weatherproof Rotary Isolator Switch - 4 Pole - 415V - Grey
Size	100mm (W) x 125mm (H) x 120mm (D)
Range	Selectric Seal - IP65 to IP68 Rated Accessories
Colour	Grey, yellow & red
Knockouts?	4 x knock-out cable entries - 2 top + 2 bottom (20mm or 25mm)
Wall Mountable?	Yes
Lockable?	Lockable in OFF position
Amps / kW	16 Amp - 8kW
IP Rating	IP65
Included	Instructions
Weight	0.45kg
Inner Carton Quantity	1
Barcode	5025117987148
Standards	BS EN 60947-3
Notes	<ul style="list-style-type: none"> • On load switch disconnectors • Surface mounting with polycarbonate housing • The impact resistant base and cover will survive the hardest knocks in almost any installation • The two sections are sealed with a weather seal gasket • Heavy duty & weatherproof, for indoor or outdoor use • IP65 – Protected against dust that may harm equipment. Protected against water spray from all directions